

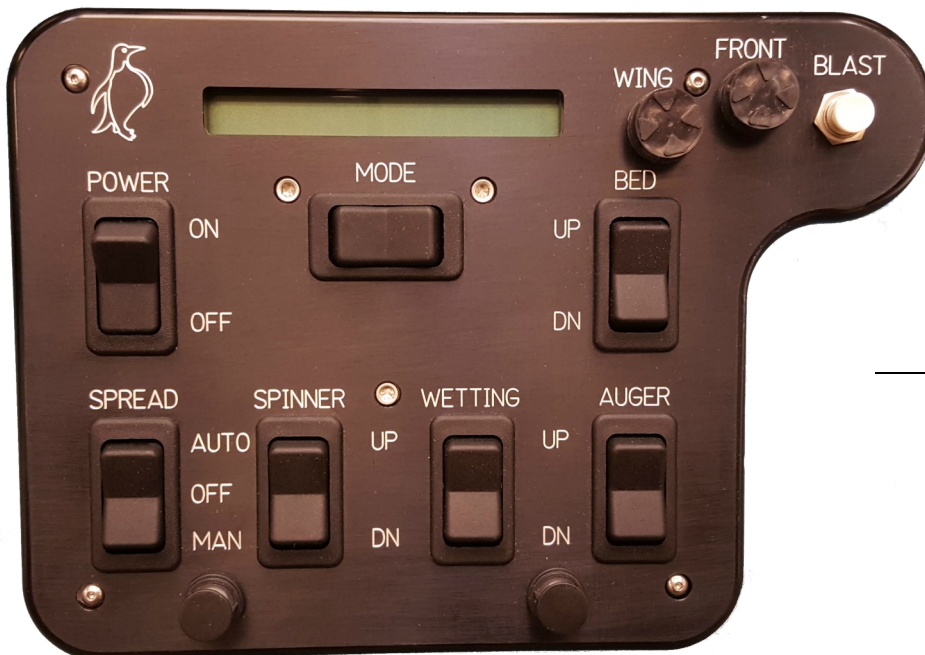

1st Edition
Revision 1.09
3-20-2018

Truck ID #	
User	
Manifold #	
Pump #	
Control Box #	
Valve Driver #	
S.O. #	
P.O. #	

485-2P-W-MS CONTROL BOX Technical Manual



PENGWYN
 2550 W. FIFTH AVENUE
 COLUMBUS, OH 43204



PENGWYN
CENTRAL HYDRAULIC SYSTEMS

485-2P-WING-MS CONTROL BOX

PENGWYN
2550 West Fifth Avenue Columbus, OH 43204
Customer support: Phone 800.233.7568 • Fax 614.488.0019
www.pengwyn.com

Table of Contents

<u>Introduction</u>	4
<u>Caution</u>	5
<u>Limited Warranty</u>	6
<u>Control Box Layout</u>	7
<u>Switch Layout</u>	8
Spreader Controls	8
Bed/Plow Controls	9
User Interface Controls	9
<u>Modes</u>	10
<u>Alarms</u>	12
<u>Spreader Operation</u>	14
<u>Wetting Operation</u>	15
<u>Control Console Calibration</u>	16
Calibration Map	17
<u>Calibration Settings</u>	18
Adjust Speed	18
Adjust Auger	20
Adjust Wetting	22
Adjust Clock	23
Adjust Miscellaneous	24
Adjust Bed/Plow	25
Reset Constants?	26
Blast to Exit	26
Maintenance Mode	27
<u>Programming Constants Table</u>	28
<u>Troubleshooting</u>	30

Introduction

Thank you for choosing our ground-oriented central hydraulics system. Our goal has always been to provide great customer service and a safe, reliable product that emphasizes:

- **Simplicity of operation**
- **Operator safety**
- **Management control**
- **Reduced operating costs**
- **Year round usage**

In order to reach our goal of reliability, your new Pengwyn system uses the rugged Autosucker™ on-demand pump. It has a dry valve design with fixed displacement that generates hydraulic flow to a series of poppet-style solenoid cartridge valves. Poppet valves are bang-bang solenoid devices which means they are either on or off. They are reliable, dirt tolerant, inexpensive to repair, contain only static seals, and are not damaged by long periods of sitting idle. These features, as well as the testing done on each system before it leaves the facility, contribute to the overall dependability.

Not only is your new system reliable, but it has been designed to be safe and easy for the operator, as well as the maintenance personnel. The operator has complete control of all the functions with the touch of a switch on the control console. This allows the operator to concentrate on the road. Another feature to help the operator is the system of alarms. The alarms alert the operator to any problems with a jam on the conveyor, low material on the conveyor, high hydraulic fluid temperature, and low hydraulic fluid level. This again keeps the operator from diverting attention from the roadway. Another safety consideration includes having all the hydraulics on the exterior of the cab and away from the operator.

Pengwyn systems allow management to secure programming of spreader constants which reduces de-icing material usage.

Please look to this manual for information on the major features, calibration of the system, and troubleshooting guidelines. This manual will help you operate and maintain your system. Pengwyn does offer training. We are available by calling 1-800-233-7568. Please call if you have a problem.

Caution

DO NOT OVER TIGHTEN SOLENOID COIL NUT; THE COIL SPINDLE IS HOLLOW AND EASILY DAMAGED. BE CAREFUL NOT TO PINCH WIRES UNDER COIL WHEN INSTALLING.

TURN THE PENGWYN CONTROL CONSOLE POWER SWITCH OFF BEFORE CONNECTING AND DISCONNECTING BATTERY CABLES, BATTERY CHARGERS, OR JUMPING THE TRUCK BATTERY.

DO NOT DRILL HOLES IN OR MOUNT AUXILIARY SWITCHES TO THE PENGWYN CONTROL CONSOLE. THIS WILL VOID THE WARRANTY AND RISK PERSONAL INJURY. USE THE CONTROL CONSOLE MOUNTING BRACKET FOR THIS PURPOSE.

DO NOT EXPOSE THE PENWGWYN CONTROL BOX TO MOISTURE. THIS INCLUDES PRESSURE WASHING INSIDE THE CAB AND WILL VOID THE WARRANTY. WATER CAN CAUSE CIRCUIT BOARDS TO FUNCTION ERRATICLY AND CAN LEAD TO INJURY OR DEATH.

Limited Warranty

Pengwyn warrants 485 Series components to be free of defects in material and workmanship, under normal use and service for a period of two (2) years from date of shipment. Pengwyn's obligation under this warranty is limited to repairing or replacing at its factory, or other location designated by Pengwyn, any part or parts thereof which are returned within thirty (30) days of the date when failure occurs or defect is noted, with transportation charges prepaid, and which upon examination appears to Pengwyn's satisfaction to have been defective. **Such free repair or replacement does not include transportation charges, or the cost of installing the new part or any other expense incident thereto. Pengwyn will not be liable for other loss, damage, or expense directly or indirectly arising from the use of its products, nor will Pengwyn be liable for special, incidental or consequential damages.**

Ordinary wear and tear, and damage from abuse, misuse, neglect or alteration are not covered by this warranty. Pengwyn assumes no liability for expenses incurred or repairs made outside Pengwyn's factory except by written consent. Pengwyn's warranty also does not cover the requirement of control box programming. All control box programming is to be performed by the end user with the use of the technical manual. This warranty is null and void if instructions and operating procedures are not followed.

Equipment or parts not manufactured by this company, but which are furnished in connection with Pengwyn products, are covered directly by the warranty of the manufacturer supplying them. However, Pengwyn will assist in obtaining adjustment on such equipment or parts when necessary.

It is recommended that spare parts be purchased for critical items to allow continued operation of equipment during the inspection, evaluation, or repair/replacement process.

THIS WARRANTY IS IN LIEU OF ALL OTHER WARRANTIES EXPRESSED OR IMPLIED INCLUDING ANY IMPLIED WARRANTIES OF MERCHANTABILITY OR FITNESS FOR A PARTICULAR PURPOSE AND OF ANY OTHER OBLIGATION OR LIABILITY OF PENGWYN.

PRODUCT IMPROVEMENT LIABILITY DISCLAIMER

Pengwyn reserves the right to make any changes in or improvements on its products without incurring any liability or obligation whatever and without being required to make any corresponding changes or improvements in products previously manufactured or sold.

Control Box Layout

485-2P-W-MS

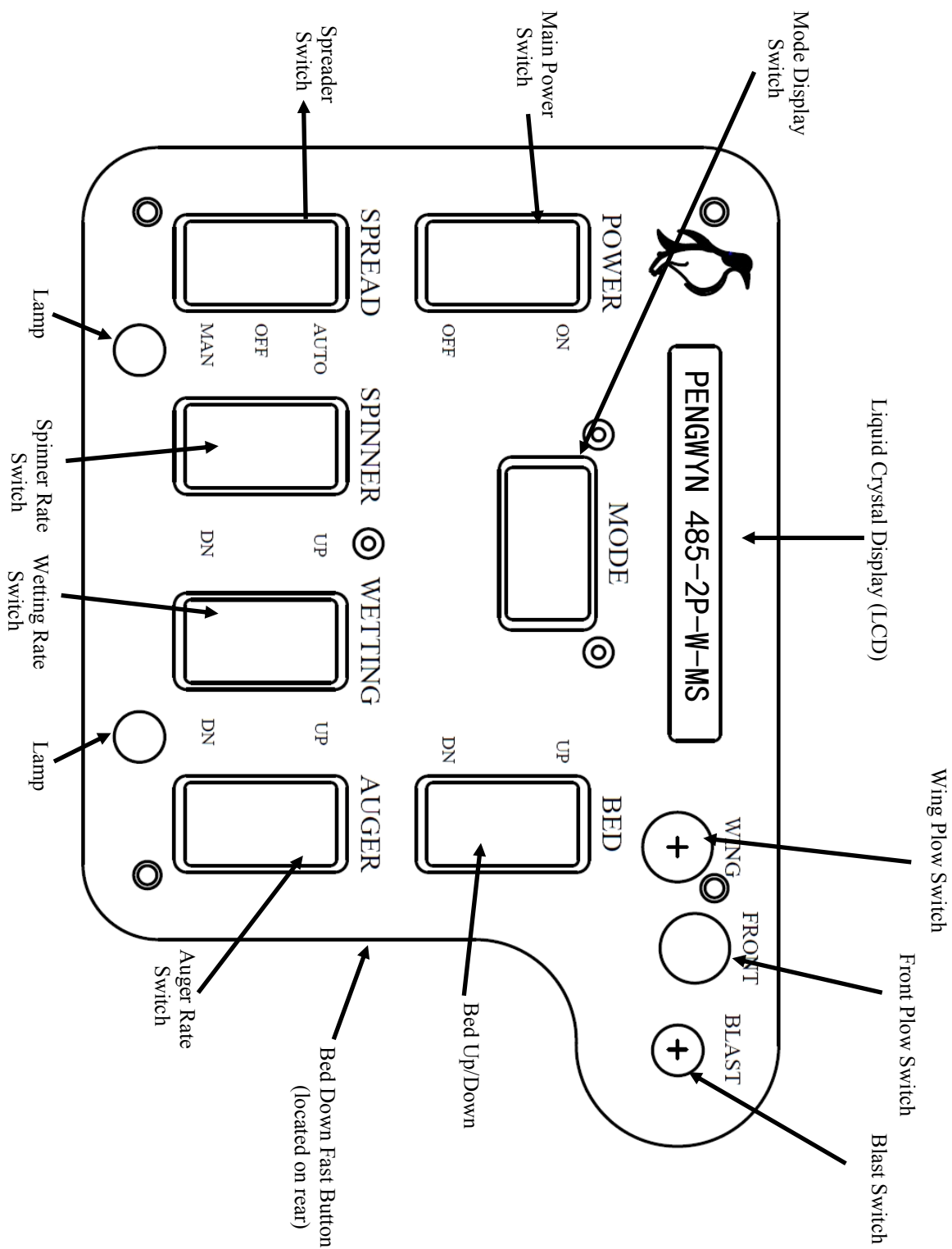

Switch Layout

Spreader Controls

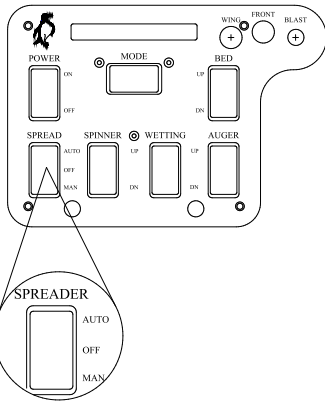

SPREAD Switch

The spreader switch has three positions: **AUTO**, **OFF**, and **MAN**. **MAN** position is only active if the manual setting is enabled in Calibrate Mode. When in **AUTO** mode, hydraulic flow to the auger motor is ground oriented. If the spreader is switched **OFF** no motors receive hydraulic flow. For more information on these settings, refer to the Operation section of this manual.

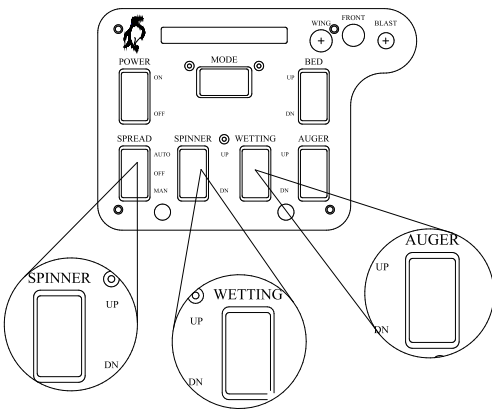

AUGER, **WETTING**, & **SPINNER** Rate Switches

These momentary switches are used to change the rate for the motor you wish to control. When pressed these switches increase or decrease the rate of the hydraulic motor printed above the switch.

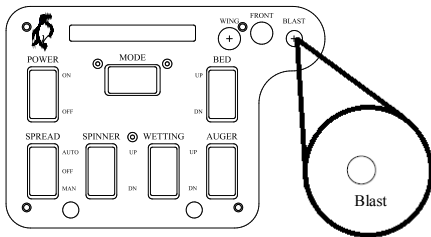

BLAST Switch

The blast switch is a yellow push button mounted on Joystick face (left center). This button is used to override the setting of the auger in any mode of operation. When activated, the blast switch energizes all the auger and/or wetting valves, sending maximum hydraulic flow to the auger drive motor and/or wetting pump, putting out maximum material. When released, the switch returns to its **OFF** position and the spreader returns to the previous output setting. This is only intended to be used sparingly when going through intersections, over bridges, or wherever a higher application rate may be needed.

NOTE: Blast can also be used for “Spot” salting, where material is required only in certain parts of the roadway. To do this, set spinner to desired setting, Wetting and Auger to 0, and turn SPREAD to Manual or Auto. Press blast wherever material is required.

Bed/Plow Controls

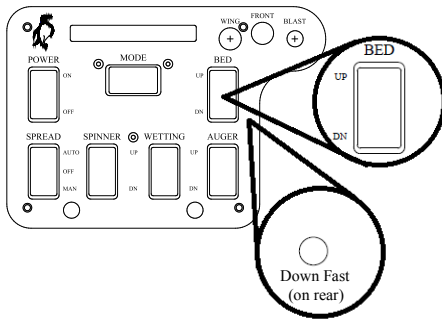

Bed Switch

There is a bed switch and a bed down fast button. In order to operate bed cylinders at normal speed switch can be pressed to Up or Down. To lower the bed at a faster rate Press the Switch to Down, and hold the Down Fast button (push button on the Back of the control box) at the same time.

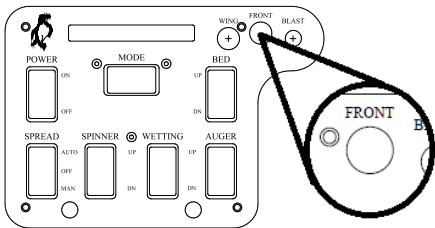

FRONT Plow Thumb Control

The front plow thumb-controller is located in the top right of the control box (center thumb controller). The five-position thumb-controller directs plow movement up and down as well as the plow angle left and right.

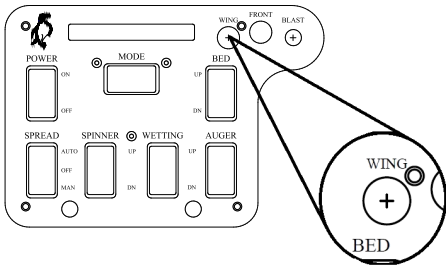

WING Plow Thumb Control

The Wing Plow thumb-controller is located in the top right of the control box (Left thumb controller). The thumb-controller directs the wing Plow movement up and down as well as the plow angle.

User Interface

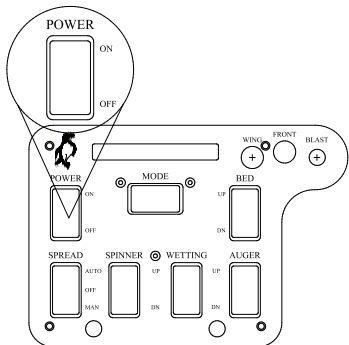

POWER

When the power switch is first flipped to the ON position, the panel will light up and the display will come on. The system will initialize and run several communication checks with the Valve Driver Board. The display will briefly show the system number and then switch to Miles/hr readout. If your control console does not complete this sequence, have the system checked by a qualified technician.

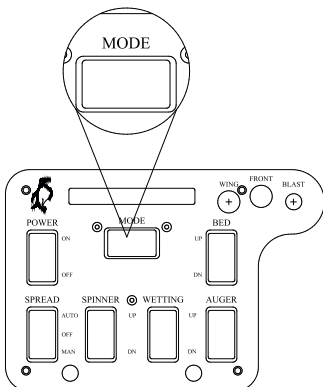

MODE

The Mode selection switch is centered under the LCD display. The switch is a 3 position momentary type that allows the user to “scroll” through the available display modes. As you scroll through the available modes, the display will briefly read “MODE XX”, where “XX” is the corresponding mode number. The Mode information will then be displayed.

LCD Modes

MODE 1

MILES/Hour 35.9

Displays the current speed of the truck in miles per hour.

MODE 2

Lbs/Mile 197

Displays the current spreading rate of the truck in lbs. of material per mile.

MODE 3

THU 1:47:36 PM

Displays the day of the week and the time of day.

MODE 4

SEP 14 2017

Displays the calendar information.

MODE 5

TOOL MODE

START 0FT

This mode differs based on the Spreader setting. In manual, this is TOOL MODE, allowing hydraulic tool to be run off the Pengwyn manifold without nuisance temperature and pressure alarms. This is described in detail below. With the Spreader in Automatic, there is no applicable function. If the spreader is switched off, this mode may be used for distance measuring feature in FEET. Use the blast button to Start/Stop measuring.

MODE 6

TOOL MODE

START 0.0 MI

This position differs based on the Spreader setting. In manual, this is **TOOL MODE**, allowing hydraulic tools to be run off the Pengwyn manifold without nuisance temperature and pressure alarms. This is described in detail below. With the Spreader in Automatic, there is no applicable function. If the spreader is switched off, this mode may be used for distance measuring feature in MILES. Use the blast button to Start/Stop measuring.

NOTE: In order to run tools off the Pengwyn system, you must connect the pressure hose of the tool to the pressure side of the auger circuit and the return hose of the tool to the return side of the spinner circuit. Manual Mode must be enabled and TOOL MODE must be displayed. Bring the truck engine speed up to approximately 1000 RPM. The switch labeled auger will allow you to select the gallons per minute needed for the tool. Each setting is equal to the gallons per minute. Therefore, position 1 gives one gallon per minute of flow and so on. Keep in mind that alarms are deactivated in Tool Mode.

LCD Modes Continued...

1.5M 233 P

MODE 7

Displays the distance traveled in miles and material usage in pounds for each trip. It can be reset by turning the spreader switch off and hitting the blast button.

MODE 8

SPN 2 AUG 5 WT 1

Displays the current setting for the Spinner, Auger, and Wetting motors.

MODE 9

1500/ 800 PSI

Displays the hydraulic pressure in pounds per square inch (PSI). High-pressure sensor readings are on the left while a differential pressure reading is on the right (Main Pressure—Pressure after Auger/Conveyor Motor).

NOTE: Max pressure reading is 2715 PSI. Any pressure higher than this will result in a

PSI OFF SCALE

message in this mode, and cause and

OVER PRESSURE

Alarm in all

other Modes.

MODE 10

Fluid Temp 80°F

Displays the hydraulic fluid temperature in degrees Fahrenheit.

MODE 11

Calibrate Mode?

Used for gaining access to the calibrations. Access by pressing the blast button while the spreader switch is in the off position, enter the 4 digit pass code using the plow switch, then press the blast button again.

NOTE: If Passcode has been lost, Please contact PENGWYN technical assistance.

MODE 12

User Settings?

Used for gaining access to settings that do not require a pass code. These settings include turning on/off counterbalance and broom mode. It also has the option to turn on speed simulation from 0-60 MPH in 5 MPH increments. This can be used to simulate automatic while the truck sits still. Press the blast switch to enter user settings and also use blast to exit and save any changes.

NOTE: Be sure these Options are set according to your organizations guidelines. These settings are intended to provide quick access to commonly needed operator functions for troubleshooting and truck setup.

Alarms

LOW FLUID

This warning indicates that the hydraulic fluid in the reservoir tank is low. The display will flash “**LOW FLUID**” and create an audible beep. Also, all spreader functions will be disabled. The bed and plow functions will remain in operation as long as there is some fluid in the tank. If the fluid level is low, immediate maintenance is recommended. To override a faulty low oil alarm and enable spreader functions, turn to **MODE 8** with the spreader switch off and hit the blast switch.

FLUID HOT

This warning indicates that the temperature has exceeded the maximum recommended operating temperature (default is 150°F). The control box will produce an audible beep and the display will flash “**FLUID HOT**”. The current hydraulic fluid temperature can be displayed by scrolling to **LCD MODE 10** on the main menu. Immediate maintenance of the truck is recommended.

MOTORS OFF 165°F

If the Fluid Temperature goes above a factory set, non-adjustable limit of 160° F, Pumps are shut down, an alarm sounds, “**MOTORS OFF XXX°F**” is displayed (where XXX is the oil temperature), and valve control is suspended. Once hydraulic oil temperature falls below 160°F function can be regained by turning spreader switch to the OFF position. Immediate maintenance of the truck is recommended.

MANUAL MODE OFF

This warning indicates that Manual mode has been selected with the Spreader Switch while Manual Mode is disabled in the Calibration menu. The factory default is Manual Mode on, to enable/disable Manual Mode see “**Calibration Settings**” section of this manual.

BAD TEMP SENSOR

This warning indicates that the temperature read is below the Minimum temp that can be measured by the system. A reading of -38°F to -42°F indicates a bad or missing Temperature sensor circuit. This warning will regularly show in the display warning the operator that they will not get important temperature alerts, but does not stop system functions.

Alarms Continued...

SPREADER ALERT

If there is an audible beep and the control box display flashes "SPREADER ALERT", material load on the auger has dropped below the preset minimum (set during calibration). If Automatic vibrator connection is installed it will be triggered as well. Spreader Alert indicates that there has been a reduction of the load on the hydraulic drive motor. Generally, this is caused when the spreader is running out of material. Other causes include:

- Tunneling/bridging of the material
- A broken mechanical connection between the drive motor and the auger/conveyor
- Blown hose on the auger/conveyor drive motor

SPREADER JAM

Spreader Jam will cause an Audible beep and the control box will flash "SPREADER JAM". This Indicates that Hydraulic pressure has exceeded the maximum (default is 2500PSI), and no material is being ejected by the spreader. It may be caused by a material jam at the auger/conveyor or a quick disconnect to any of the drive motors may not be connected.

OVER PRESSURE

This warning indicates that hydraulic pressure has exceeded the maximum measureable pressure (2715 PSI), while hydraulic motors are not engaged (i.e. Spread switch is in the off position or in Auto at 0MPH). This condition can occur when a hydraulic pump controlled by a manual switch is put into a deadhead condition.

PSI OFF SCALE

This warning indicates that hydraulic pressure has exceeded the maximum measureable pressure (2715PSI) while in Mode 9.

TURN SPREAD OFF

CHECK BED SWITCH

CHECK PLOW SWITC

TURN OFF SPREAD

If any spreader or cylinder function switches are active when box is turned on, one of these alerts will be displayed, and boot up will halt. If condition cannot be remedied by releasing or resetting a switch, control box will need to be serviced by a qualified technician.

Spreader Operation

Very Cold Temperature Operation

During extremely cold weather with the spreader off the hydraulic fluid viscosity may become so thick that hydraulic functions become very sluggish. To remedy this, two procedures will help:

1. Set the **AUGER** to **0**, the **SPINNER** to **2**, and the **SPREAD** switch to **AUTO**. This will allow continuous circulation of the pump with the spreader off.
2. If more rapid hydraulic fluid warming is desired, hold the plow switch **UP** dead heading the plow cylinder and forcing the oil over the plow relief valve. This will warm the oil approximately five to ten degrees per minute.

AUGER

The auger has 15 settings. If the spreader switch is on **MAN**, and manual mode is enabled, each numerical setting provides a fixed flow to the auger circuit. Setting **1** will provide **1** GPM of hydraulic oil to the auger circuit, setting **2** provides **2** GPM, and so on up to setting **15** which is the maximum of **15** GPM. Flow to the auger circuit in Manual Mode is constant and not ground oriented.

If the spreader switch is in **AUTO** the positions will output preprogrammed values in pounds per mile (lbs/mi). This is ground oriented, flowing more with higher truck speed. setting **1** will output the amount that is programmed into it, such as **100** lbs of material per mile. Setting **2** may be set for **200**lbs. of material per mile, and so on up to setting **15**. The Pengwyn increases/decreases hydraulic flow to the auger so the operator will have an even spread rate throughout the whole speed range of the truck and maintain the output of lbs/mi that the operator has selected. When the truck is stopped, the auger will also stop.

SPINNER

The spinner has 7 settings. If the spreader switch is on **MAN** and manual mode is enabled, each numerical setting provides a fixed flow to the spinner circuit. Setting **1** will provide **1** GPM of hydraulic oil to the spinner circuit and so on up to **7** GPM at setting **7**. The flow rate is always the same as the setting number. Flow to the spinner circuit in **MAN** is constant and not ground oriented.

In **AUTO**, spinner settings **1** through **7** operate just as in **MAN**. The flow is not ground oriented and the spinner will continue to turn even when the truck stops.

Wetting Operation

WETTING

Liquid wetting (such as calcium chloride or salt brine) is pumped from an on-board storage tank onto the granular material at the spinner or directly onto the road surface. When operating the spreader in manual, the setting numbers correspond to the amount of hydraulic flow in 2 Gallon Per Minute (GPM) increments being sent to the wetting system. Setting 1 provides 2 GPM, setting 2 provides 4 GPM, and so on up to setting 7 which provides the maximum of 14 GPM.

Pre-Wetting

Pre-wetting sprays liquid wetting agents directly onto the salt as it is being spread (at the spinner, in the salt trough, etc.), and is set in “Gallons Per Ton” (GPT). The Pre-Wetting rate can be adjusted in 1GPT increments up to Wetting Max. Wetting Max is set in the Calibration Menu, Default is 60GPT. In order to enter Pre-Wet Mode the Auger or Spinner must be set to a value greater than 1, and wetting must also be greater than 1. the **SPREAD** switch must be in **AUTO** as pre-wet mode only has an effect in ground oriented operations. This puts the control box in pre-wet mode which displays wetting settings in GPT, and uses Pre-Wet constants set up in the Calibration menu (see “Calibration Settings” section)

Direct Application Wetting

In Direct Application (D-APP) spray bars apply liquid deicers directly onto the road surface. Rates are set in Gallons Per Mile. To do this, put the spreader switch in automatic mode, set **AUGER** and **SPINNER** to 0, set **WETTING** as desired. Each of the wetting settings can be set from 10 to 100 gallons per mile in 10GPMi with default settings. Each setting can be assigned a specific value (in 10 GPMi increments) in the Calibration Menu.

Control Console Calibration

Calibration Mode is used to monitor and change constants vital to the operation of each individual unit. Different models of trucks and spreader combinations will require different values.

Caution: Always exit Calibrate mode before turning the console power switch or the truck key off. Turning the power off before exiting Calibrate mode will cause the loss of the newly programmed numbers. Exiting Calibrate mode will save all programmed constants to the PENGWYN memory.

Enter “Calibration Mode” by pressing the Blast Switch at the prompt (“MODE 11”) and entering the passcode (see end of manual for default passcode). The Calibration Map on the following Page can be used as a guide for menu navigation.



Unless otherwise noted, all settings in the Calibration mode can be adjusted using the same method:

- Front Plow Thumb-control navigates through the menus. Left/Right scrolls through menu headings, Up/Down scrolls to calibration values and sub-headings.
- Bed controls set values by listed increments. Bed UP = Increment; Bed Down = Decrement.
- If a large change must be made, holding the Down Fast button while operating the bed control will increase the step size.

- In order to save entered values, you must scroll to  , and exit the Calibration menu. If power is lost (i.e. by turning the control box or truck key to the off position) newly entered calibration values will not be saved. In Calibration mode all functions other than adjusting settings are disabled. Any direction to run hydraulic motors etc. will need to be done in “RUN Mode” outside of the Calibration menu.

Calibration Map

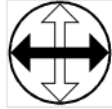
Below is a representation of the Calibration Menu of the Pengwyn 485 Series control console. Navigate through the submenus using the controls shown.

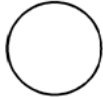
Format:	 FRONT	 FRONT	 BED	 BED DOWN FAST
Cal. Heading				
Cal. Function				
Cal. Function				
Cal. Function				
Cal. Function	Press front plow switch	Press Front Plow Switch	Use up/down	Hold down fast and bed to
Cal. Function	Left or Right to scroll	Down to scroll available	control to Adjust	Change values at faster
Cal. Function	Calibration Headings	Calibration values		rate

ADJUST SPEED		ADJUST AUGER		ADJUST WETTING		ADJUST CLOCK	
CAL MPH	XXX	AUGER	XXX	WETTING MAX	XXX	SET HOUR	XX-XX
PULSE/ .1 MI	XXX	AUGER LBS/MILE	XXX	PUMP SLIP	XXX	SET MIN	XX:XX
SPEEDOMETER	XXX	AUGER JAM	XXX	GPT CONST	XXX	SET AM/PM	XX
		AUGER MIN	XXX	DIR APP SLIP	XXX	SET DAY	XXX
		AUGER DRAG	XXX	GAL/GAL CST	XXX	SET DATE	XXX XX
		AUGER SLIP	XXX	G/MI RATE	XXX	SET MONTH	XXX XX
		BLAST HOLD	XXX			SET YEAR	XXXX
		BLAST TIMEOUT	XXX				
		SPREADER ALERTS					

ADJUST MISC		ADJUST BED/PLOW		RESET CONSTANTS	BLAST TO EXIT	MAINTENANCE MODE
ALARM TEMP:	XXX	PLOW CYL.	XXXXX	BLAST TO RESET +		BLAST TO ENTER
BEEP OPTION:	XXXX	BED CYL.	XX	BED UP		AUTO TO TEST
MANUAL MODE	XXX	SHAKER	XX			
SET PASS #	XXXX	SCRAP PERIOD	XX			
MANIFOLD	XXXX	SCRAP PULSE	XX			
HEARTBEAT	XXX	PLOW CB	ON/OFF			
XXXX MILES	XXTONS	PLOW INVERT?	XXX			

NOTE: Default Values are listed in "Programming Constants Table" at the end of this manual

Calibration Settings

Adjust Speed

CAL MPH 0.0

This screen is used to monitor and compare system speed reading with Truck speedometer to find the **PULSE/.1MI** constant (see “Finding Speed Constant” in this section). Bed controls adjust **PULSE/.1MI** setting while in this mode.

PULSE/.1MI 3000

Used to store the Speed Constant identified in “Finding the Speed Constant” in this section. It is the calibration factor that synchronizes truck speed to measured speed. Once the Speed constant has been identified (a number between 550 and 9999) it must be entered here. Default is 3000.

SPEEDOMETER: SQR

This Stores the speedometer type (**SINE** for Manual Transmission, **SQR** for Automatic transmission). This should be set before any speed calibration is attempted. Default is **SQR**.

Finding the Speed Constant

The control console must read the same speed as the truck speedometer to ensure that Ground oriented operation is accurate. In order to make these systems agree we must make sure the speed constant (stored in **PULSE/.1MI**) is correct. Once the MPH calibration is completed for a truck the pulse constant will always remain the same for the life of that truck. Below are the procedures that can be used to find the speed constant:

Real-time Speed calibration:

NOTE: Be prepared to drive the truck at 30MPH, and have someone available to program the control box to safely use this method. A method for using a measured mile that can be safely completed by a single operator follows in the Distance Measuring section.

SPEEDOMETER SQR

1. Be sure that **SPEEDOMETER SQR** is set to the correct setting for the truck being calibrated.
2. Refer to the Calibration Map at the beginning of this chapter and locate **CAL MPH 0.0** under the **Adjust Speed** heading.
3. Operate the truck at a constant speed (30 MPH or more).
4. Compare truck speedometer to speed shown on control console display.
5. Use **Bed Up/Down** control to synchronize the **CAL MPH** readout to the truck speedometer.
6. Scroll to **PULSE/.1MI** under the **Adjust Speed** menu.
7. Record the pulse count shown for your records.
8. Exit Calibrate Mode to save values.

Distance Measuring Constant (using a surveyed mile):

NOTE: For this method you will need access to an accurately measured stretch of roadway (400ft. minimum). Be prepared to drive the truck multiple times over the same course to verify the calibration.

1. If in Calibration mode, scroll to **Blast to Exit!**, and press Blast to exit calibration. (you must be outside of calibration to access distance measuring modes).
2. Make sure **SPREAD** Switch is **OFF**.
3. Toggle the Mode Switch until you see **(MODE 5)**, **START 0FT** or **START 0.0MI** **(MODE 6)**. Use the mode that matches the units that were used for the Measured Distance.
4. Drive the truck toward the starting point of the measured mile.
5. Press the **BLAST** switch when at the starting point.
6. The display will read **RUN 0FT** and increase as the truck continues toward the mile marker.
7. Bring the truck to a stop at the end of the measured distance and press the **BLAST** switch when the end of the measured mile is reached.
8. The display will now show **STOP XXFT**. “XX” is the feet the control box counted over the measured distance.
9. Record the number shown (it will be used in the formula below).
10. Use this formula to determine the new PULSE/.1MI constant to be programmed into the console (This calculation can be used for any measured distance over 400 ft).

$$\frac{\text{Measured distance (from control box) X (PULSE/.1MI from control box)}}{\text{Actual distance traveled}}$$

1. Program the result into **PULSE/MI XXXX**

Adjust Auger

Cal Auger 60

Is used to store the “Auger Constant”. The spreader constant is used in the calculation of material to be spread (lbs/Mi) in Automatic mode, and is the ratio between Hydraulic fluid sent to the motor to material spread. (See “Finding Auger Constant” in this Section)

Lbs/Mile 1- 50

Lbs/Mile XX-YYYY

This setting displays where “XX” is the step number, and “YYYY” is the lbs/Mile. It is used to store the pounds per mile presets for each Auger step in Auto (i.e. the amount of material you want to spread for each setting in Auto). For example; setting 1 can be set to 200lbs/Mile, step 2 can be set to 250lbs/Mile, and so on. Steps can be set to any value up to 1500lbs/Mile. To set these values, use the Auger Switch to select the step, and the bed controls to set the lbs/Mile value. Defaults are listed in the “Programming Constants Table” at the end of this manual, and are in 50lb increments up to 750lbs/Mile.

Auger Jam

SPREADER JAM

This sets the system pressure that will trigger a “deadhead” or motor stall condition. It can be set from 100-2715 PSI in 1 PSI increments. This setting should be set approximately 200 PSI below the Main Relief Valve setting. Default setting is 2500 PSI, factory set Main Relief valve is 2700PSI @ 18GPM.

Auger Min 1

When operating in the automatic mode, the PENGWYN system is setup to send a minimum hydraulic flow rate to the auger/conveyor drive motor, regardless of the amount of material output requested. This is to compensate for the hydraulic motor’s inefficiency which would otherwise result in low/no material output when starting the truck from a dead stop. This is the minimum amount of hydraulic oil that will be sent to the auger/conveyor motor in Auto. The minimum value is adjustable from 0 to 5 in 1 GPM increments, and the default is 1.

NOTE: A setting of 1 is recommended for single axle trucks, and a setting of 2 for tandem axle trucks.

Auger Drag

SPREADER ALERT

Auger drag sets the minimum Salt load that will trigger a . The number shown is the pressure above the empty auger fault where the Pengwyn sounds the alarm. Settings range from 50-120, and default is 50. This number varies with the type and make of the spreader used on the truck.

Auger Slip

This number sets the amount of additional hydraulic fluid needed (in GPM) to compensate for motor wear or slippage, and is applied in Automatic mode only. Default value is .5 GPM, and can be adjusted from .25 to 2.00 GPM in .25 GPM increments.

Blast Hold

When the BLAST switch is pressed momentarily it can be set with this number to continue the blast function for a set period of time between 1 and 30 seconds. This allows the operator to trigger the blast function when a section of road is in need, but keep his hands (and focus) on controlling the truck. If the Blast function is operating in the Blast Hold time period, hitting the Blast button again will shut the blast function off. For intersections, while in Auto, blast can be pressed before the truck moves. The Blast timer will start, but material will only be spread as the truck begins to move.

Blast Timeout

Blast Timeout sets a limit to the amount of time that blast can be engaged (1-15 seconds or OFF). If an operator holds down the blast button longer than this setting allows, **BLAST TIMEOUT** is displayed, and the blast function will stop. If Blast Timeout is set to “OFF” (minimum setting) there is no limit to how long blast can be engaged. Default is 5 seconds.

NOTE: Blast Timeout is based on holding the button, and will not affect Blast hold unless the Blast button is held down.

Auger Alerts

Allows you to review the auger/conveyor motor load pressures recorded When Maintenance mode is run. To view alert values:

1. Press blast to enter
2. Use Front Plow Down to begin scrolling (if you push Front plow up while viewing setting 1 you will exit the menu)
3. Once you have reached setting 15 pressing Front Plow Down will exit the menu..

Defaults are listed in the Programming Constants Table at the end of this manual, and can only be changed by running Auger Alerts Calibration (as described in **Maintenance Mode** in this section).

Note: Auger Alerts Calibration (“Maintenance Mode”) must be run periodically to maintain accurate Auger alert function.

Finding the Auger Constant

Note: You will need a stop watch to time the procedure.

1. Fill the bed of the truck with material to be spread at least half way
2. Make sure the spreader system is attached and operating correctly.
3. Weigh an empty bucket capable of holding **30 to 90 lbs** of your granular deicing material.
4. Position bucket under output of the auger to catch the material.
5. Ensure that material is distributed evenly over entire spreader box or conveyor belt.
6. Ensure Manual Mode is enabled.
7. In “**RUN Mode**” (outside of Calibration), start the engine and bring the speed to 1500 RPM. Warm the hydraulic fluid to operating temperature (80°).
8. Turn **SPREAD** Switch to **OFF** .

Continued on next Page...

Finding the Auger Constant Continued...

- Set **SPINNER** and **WETTING** to 0.
- Set the **AUGER** to 1.
- Push the **SPREAD** Switch to **MAN** and start timing.
- Allow the system to run for 1 minute.
- Turn **SPREAD** switch to **OFF**.
- Weigh the bucket of material.
- Empty the bucket of material.
- Repeat steps 4-12 with the **AUGER** at setting 2.
- Subtract value measured at **AUGER** 1 from Au **AUGER** ger 2.
- The resulting number is the spreader constant. You may want to run through this procedure twice, in order to double check the values.
- Set **Auger Cal** to this number and record it for your records.

Adjust Wetting

Wetting MAX

Sets the Pre-wetting limit to a number between 1 and 200 gallons per ton. This number will determine the maximum output for pre-wetting operations, but does not affect direct application operation.

Pump Slip

The pump slip constant compensates for any wear on the pre-wetting pump. The constant is adjustable from 0 to 3 GPM of hydraulic fluid, and is only used in Automatic calculations.

GPT Const

This value is used in pre-wetting applications where brine, calcium, etc., is sprayed onto the material being spread. 6-BIT and 6A5W manifolds Require 1.40, other manifolds require a setting of 0.78

Dir App Slip

The direct application slip constant compensates for Slippage in the direct application pump. The constant is adjustable from 0 to 3 GPM of hydraulic fluid.

Gal/Gal Cst

This value is used in direct application wetting where brine, calcium, etc., is sprayed directly onto the road surface. 6-BIT and 6A5W manifolds require 10.8, other manifolds require a setting of 5.4

G/Mi Rate

The G/Mi Rate sets the direct application rates for each direct app setting (1-10). These rates can be adjusted from 10 to 100 Gallons per mile in increments of 10

Adjust Clock

Set Hours

Used to set the clock hours.

Set Min

Used to set the clock minutes.

Set AM/PM

Used to set AM or PM for the clock. The Pengwyn operates only on a 12 hour clock.

Set Day

Used to set the Day of the week.

Set Date

Used to set the number of the Day within the month (i.e. if the date is September 15, this setting allows you to change the "15").

Set Month

Used to set the Month.

Set Year

Used to set the Year.

Adjust Misc.

ALARM TEMP

FLUID HOT

This is the temperature that triggers **FLUID HOT** alarm. It is factory set at 150° and should not be changed unless necessary.

BEEP OPTION:ONCE

Allows you to specify how the alarm system operates. Options are Once, CONT, or OFF.

ONCE: Alarm sounds only once for each alarm occurrence (i.e. When the alarm message is shown first shown), but not again for the duration of the alarm.

CONT: Alarm sounds every time the alarm flashes on the screen, for as long as the alarm persists.

OFF: disables the beeper completely, but the alarm message will flash on the screen.

Manual Mode ON

AUTO

Manual operation mode can be disabled to ensure that the unit is always used in **AUTO** (ground oriented) with this setting.

Set Pass # 4321

A passcode is required to enter Calibration mode, and can be set with this number.

NOTE: Be sure to record the passcode for your records, as you will not be able to enter Calibrations if you do not have it. If your passcode is lost, Contact Pengwyn Technical Support.

MANIFOLD 6-bit

In order to operate the PENGWYN system correctly, the manifold to be controlled must be selected (i.e. 6-BIT, 4-BIT, 6A5W, etc.). If the wrong manifold is selected, operation of the Pengwyn system remains uncalibrated.

NOTE: Refer to manifold identification chart at the end of this manual if you are unsure what Manifold you have.

HEARTBEAT: ON

Used for specific GPS tracking companies.

.0 M 0 P

The datalog screen records total distance traveled, and material spread using this control box. To reset press Blast. **RESET DATALOG?** will appear. While Holding Blast, Press BED UP to confirm.

Adjust Bed/Plow

PLOW CYL: DOUBLE

Use this setting to select whether the plow hoist cylinder is single acting (pressure up, gravity down), or double acting (pressure up and down).

BED CYL: DOUBLE

Use this setting to select whether the bed hoist cylinder is single acting (pressure up, gravity down), or double acting (pressure up and down).

Shake Pulse 5

This setting determines how long to turn on the bed vibrator when automatic vibrator control is installed. This function is triggered by **SPREADER ALERT**, and can be set for up to 10 seconds (default is 5 seconds).

SCRAP PERIOD OFF

To ensure that under body scrapers keep appropriate pressure on the scraper, there is a scraper recharge pulse activated whenever UB Down switch is pressed. The scraper period is the time between under-body scraper pulses. Default is OFF, and can be set from 1 to 90 seconds.

SCRAP PULSE 1

Sets the Duration of the under-body scraper recharge pulse. Default is 1 second, and it can be set from 1 to 4 seconds.

PLOW CB PULSE 7

The Plow Counterbalance circuit, when installed, automatically shifts some of the plow load off of the cutting edge and onto the front truck suspension. The Plow CB Pulse determines the amount of time in seconds the Counter Balance circuit will operate after the plow down is activated. The CB relief valve in the manifold will limit the plow lift force, and must be set correctly before counterbalance can be used.

PLOW INVERT?: NO

It is possible to invert the front, scraper, and wing plow vertical controls to match operator preference. Default value is 'NO'.

RESET CONSTANTS?

In the rare event that the constants saved in the control box memory become scrambled, it is recommended that you reset constants. To do this press and hold the Blast button. A message will display

ARE YOU SURE?

while continuing to hold the blast button, use the Bed Up control to verify your selection.

NOTE: ALL settings will return to Factory Defaults (As listed in the “Programming Constants Table” in this manual). Previous settings can be entered through the calibration menu, or with a laptop and the PENGWYN software.

Blast to EXIT!

Pressing Blast at this prompt will exit “Calibration Mode” back to “Run Mode”, and all changes made to calibration settings will be saved.

NOTE: If this method is not used to exit (i.e. power is lost to control box) changes made will be lost.

Maintenance Mode

Unless loading previous constants from a laptop, this procedure must be done if a control box is changed. The procedure should be repeated occasionally as a standard maintenance check to adjust for auger/conveyor or motor wear. The procedure should also be done any time the auger/conveyor motor is changed or the design of the spreader is changed. This is to ensure accuracy, and prevent nuisance spreader alert alarms.

1. Start the truck engine.
2. Make sure the spreader box or conveyor belt is completely empty, and able to move freely.
3. In “RUN Mode” Toggle the **MODE** Switch to Oil Temperature (**Mode 10**).
4. If temperature is below 80°F, then warm up the hydraulic oil to at least 80° by running truck at 1800 rpm and holding the plow switch in any direction.

NOTE: Maintenance mode will not run if Hydraulic Fluid temperature is above 120°F, or Below 60°F, and **FLUID TEMP RANGE will be displayed if test is attempted.**

5. Refer to the Calibration Map at the beginning of this chapter and locate **Maintenance Mode**.
6. Press Blast to enter.
7. Set and maintain 1800 rpm engine speed.
8. **AUTO TO TEST** will be displayed and will flash to **BLAST TO EXIT** until test is either started or aborted.
9. Put spreader switch into **AUTO** position to start test.
10. The display will read **SPREADER CALIB.**
11. The display then will read **START UNLOAD CAL** and then, **SETTING 1 = XXXX**, **SETTING 2 =XXXX**, and so on as it tests the load pressure on the auger motor. The displayed pressure readings should increase for each setting.
12. This will continue automatically up to **SETTING 15 =XXXX**

NOTE: If pressure errors are encountered, the system will not run the test and will display **PRESSURE ERROR (Check pump coil operation; check pressure sensors and wiring).**

13. The display will read **FINISHED**, and then **TURN SPREAD OFF**.
14. Turn **SPREAD** to **OFF**
15. Lower engine speed.
16. Press Blast to exit Maintenance mode to the main Calibration menu
17. Navigate to **Blast to Exit!**
18. Press Blast to exit calibration mode and save values.

Programming Constants Table

Settings	Default	Calibrated Value
SPEED		
PULSE/ .1 MI	3000	
SPPEDOMETER	SQR	
ADJUST AUGER		
CAL AUGER	60	
SETTING	LBS/MILE	
1	50	
2	100	
3	150	
4	200	
5	250	
6	300	
7	350	
8	400	
9	450	
10	500	
11	550	
12	600	
13	650	
14	700	
15	750	
AUGER JAM	2500	
AUGER MIN	1	
AUGER DRAG	50	
AUGER SLIP	1	
BLAST HOLD	0	
BLAST TIMEOUT	5	
AUGER ALERTS	PSI	
1	125	
2	150	
3	175	
4	200	
5	225	
6	250	
7	275	
8	300	
9	325	
10	350	
11	375	
12	400	
13	450	
14	475	
15	500	

Programming Constants Table Continued...

Settings	Default	Calibrated Value
WETTING		
PUMP SLIP	1	
GAL/TON CONSTANT	1.4 (Based on Oberdorfer 7000)	
DIR APP SLIP	1	
GAL/MILE CONSTANT	10.8 (Based on Hypro 9306C)	
DIRECT APPLICATION SETTING	GAL/MILE	
1	10	
2	20	
3	30	
4	40	
5	50	
6	60	
7	70	
8	80	
9	90	
10	100	

Settings	Default	Calibrated Value
ADJUST MISC		
ALARM TEMP	150	
BEEP OPTION	ONCE	
MANUAL MODE	ON	
SET PASS #	4321	
MANIFOLD	6-BIT	
HEARTBEAT	ON	
ADJUST BED/PLOW		
PLOW CYL	DOUBLE	
BED CYL	DOUBLE	
SHAKE PULSE	5	
SCRAPE PERIOD	OFF	
SCRAPE PULSE	1	
PLOW CB PULSE	7	
PLOW INVERT	NO	

Troubleshooting Chart

PROBLEM	CAUSE	SOLUTION
Stops at FET check	485 cable has a poor connection	Repair/replace cable
	FET Board Error	Try with a Known good FET Board/ Repair/Replace FET Board
Display has 8 blocks, everything works	Display has a poor connection	Repair connection/replace Display
	Software is corrupted	Re-Program
Will not hold date/time at all	Clock crystal and/or date chip failing	Replace crystal and/or date chip
Will not hold date/time with the power off	Battery back up is failing	Replace battery
Won't initialize, lights up with a blank screen	No program	Reprogram
	Not communicating with Valve Driver Board	Repair Valve Driver Board
Can't change auger/spinner rate	Control box is in 'Broom Mode'	Remove from broom mode
Nothing energizes, driver board relay constantly resets	Poor ground connection	Repair ground connection
Auger, spinner, wetting, will not come on. Box reads low fluid when it is not low	Sensor wires shorted	Check wiring
	Low level sensor failing	Replace low level sensor
Manual mode does not work	Manual shut off in calibration mode	Turn manual mode on in calibration mode
Box reads spreader jam even with the truck off	Pressure transducer failing	Check transducer wiring, repair/replace
Spreader alert keeps going off	Box needs calibrated with the truck	Run spreader fault calibration/ Maintenance Mode
Fluid hot always on	Thermistor failing	Check thermistor connections, repair/replace

PENGWYN
CENTRAL HYDRAULIC SYSTEMS

485-2P-WING-MS CONTROL BOXES

PENGWYN
2550 West Fifth Avenue Columbus, OH 43204
Customer support: Phone 800.233.7568 or 614.488.2861 • Fax 614.488.0019
www.pengwyn.com